

## STEAM BOILERS

BY

SAM WRAY

October 24, 1989

**GENERAL:** The problems of a safe and efficient steam generating plant means solving several problems inherent with steam, heat, water, air, and pressure. Water, especially with dissolved air, is aggressive to steel at high temperatures, therefore corrosion is a problem. This is only one of the problems, but each will be dealt with separately.

The top priority in any Boiler installation is SAFETY, therefore common sense, and following code recommendations is a must.

### BOILER RATINGS:

1 Boiler Horsepower = 33,600 BTU/Hr.  
 1 Boiler Horsepower = (approx) 33.5 Pounds/Hour steam  
 100 BHP = 3350 #/Hr  
 10,000 #/Hr = 300 BHP

The above ratings are based on feeding the boiler with 212 deg water. Use caution on Process Boilers!!

Each BHP should have approx 5 square feet of heating surface.

**NOTE:** Boiler may be rated larger than the burner, but never have the burner larger than the boiler!!

Superheated steam--What is it and how do you get it? Used for operating turbines for power generation.

### COMPONENTS THAT MAKE UP A STEAM GENERATING SYSTEM:

1. Boilers
2. Boiler safety valves
3. Boiler safety controls
4. Boiler burner
5. Fuels
6. Boiler feed pumps
7. Condensate return system
8. Deaerator
9. Traps
10. Boiler stack
11. Economizer
12. Chemical treatment
13. Boiler blow down
14. Turbulators
15. Fuel handling equipment

**BOILER TYPES:**

1. Cast Iron Sectional.
2. Fire Tube.
3. Scotch Marine.
4. Water Tube Boilers.

**SAFETY VALVES:**

1. Size per code.
2. Pipe to outside. Make sure to not reduce the free area.
3. Terminate vertically and use a drain fitting to keep water away from the safety valve.
4. Anchor pipe, as there will be high forces involved.
5. On pressure reducing valves, may use a small and large safety valve to prevent erosion of the large valve.

**SAFETY CONTROLS:**

1. Low water cut-off.
2. High pressure cut-off.
3. Gas train high and low pressure.
4. Pipe to blow down the sensing lines.

**BURNERS:**

1. Atmospheric.
2. Power.

**FUELS:**

1. Gas. Gas train piping. (pipe vent lines)
2. Oil. Fuel Oil Piping
3. Gas-Oil.
4. Heavy Oil. Heating and Piping.

BOILER TYPES:

1. Cast Iron Sectional.
2. Fire Tube.
3. Scotch Marine.
4. Water Tube Boilers.

SAFETY VALVES:

1. Size per code.
2. Pipe to outside. Make sure to not reduce the free area.
3. Terminate vertically and use a drain fitting to keep water away from the safety valve.
4. Anchor pipe, as there will be high forces involved.
5. On pressure reducing valves, may use a small and large safety valve to prevent erosion of the large valve.

*Can combine safety valve piping as long as free area equals both pipes or greater.*

*Use drip pan elbows to prevent water from laying on top of safety valve.*

SAFETY CONTROLS:

1. Low water cut-off.
2. High pressure cut-off.
3. Gas train high and low pressure.
4. Pipe to blow down the sensing lines.

*outlet of relief pipe to point straight up*

*Never want tubes dry and exposed to flame.*

*Pressure switch*

BURNERS:

1. Atmospheric.
2. Power.

*Heat goes right up chimney.*

FUELS:

1. Gas. Gas train piping. (pipe vent lines)
2. Oil. Fuel Oil Piping
3. Gas-Oil.
4. Heavy Oil. Heating and Piping.

*Determined by Users Insurance Co*

*liquids do not burn - have to convert oil to mist or vapor.*

*Factory Mutual*

*UL*

*Check w/ local utility also for requirements of gas train.*

*Supply and return line for oil. Pump 2-3 times. oil needed in order to keep air out.*

*Schools in Illinois are covered by State Code.*

*fuel to heat efficiency*

*Perfect combination  
is CO<sub>2</sub> and H<sub>2</sub>O vapor.*

EFFICIENCIES:

- 1. Burner Efficiency. CO<sub>2</sub>-CO-O<sub>2</sub>-H<sub>2</sub>O *less O<sub>2</sub> the better*
- 2. Boiler transfer efficiency. Stack temperature. *BTU's in to BTU's out*

*Good  
boilers  
80-85%  
efficiency*

PIPING THE BOILER:

- 1. Main Steam Valves.
- 2. Steam Header.
- 3. Return Pipe.
- 4. Condensate Line.
- 5. Chemical Line.
- 6. Blowdown.

*Never 150°F over the  
medium temp  
(i.e. steam or water temp.)*

*economizers  
save 1% efficiency for  
every 40°F drop in stack  
Temp.*

BLOWDOWN:

*All steam boilers must have blowdowns.*

- 1. Removes Impurities. Surface and Mud Leg.
- 2. Valving to be two in series. Gate & Quick Opening.
- 3. Blowdown Tank
- 4. Continuous Blowdown with preheating.
- 5. Large Floordrain.

BOILER STACK:

- 1. Materials *Steel*
- 2. Location considerations.
- 3. Thermometer
- 4. Stack temperatures.

ECONOMIZER:

- 1. Preheats the boiler feed.
- 2. Lowers stack temperature.

*Water from boiler feed pump  
then economizes to boiler.*

*Boiler efficiencies are based upon 212°F water  
not cold feedwater.*

**EFFICIENCIES:**

1. Burner Efficiency. CO<sub>2</sub>-CO-O<sub>2</sub>-H<sub>2</sub>O
2. Boiler transfer efficiency. Stack temperature.

**CONDENSATE RETURN SYSTEMS:**

1. Condensate Receivers.
2. Boiler Feed Systems.
3. Make-up water preheaters.
4. Deaerators.
5. Do not return steam from:  
Autoclaves(sterilizers) or from cooking units.

**PIPING THE BOILER:**

1. Main Steam Valves.
2. Steam Header.
3. Return Pipe.
4. Condensate Line.
5. Chemical Line.
6. Blowdown.

**BLOWDOWN:**

1. Removes Impurities. Surface and Mud Leg.
2. Valving to be two in series. Gate & Quick Opening.
3. Blowdown Tank
4. Continuous Blowdown with preheating.
5. Large Floordrain.

**TRAPS:**

1. Types.
2. Where Used?
3. What Size?

**BOILER STACK:**

1. Materials
2. Location considerations.
3. Thermometer
4. Stack temperatures.

**ECONOMIZER:**

1. Preheats the boiler feed.
2. Lowers stack temperature.

**CHEMICAL TREATMENT:**

1. Boiler Water treatment.
2. Condensate line treatment.

**FLASH TANKS:**

1. How piped.
2. Economics.

**STEAM COILS:**

1. Types.
2. Piping.
3. Control.

**STEAM CONTROLS:**

1. Control Valves. (Strainers on side)
2. Face and By-Pass.
3. Combination.

**HUMIDIFIERS:**

1. Steam Piping.
2. Controls--use normally closed valve.

**NO CONDENSATE RETURN:**

1. Cooking kettles and Autoclaves.

## BOILER TYPES AND THEIR SELECTION:

### Cast Iron Sectional:

Cast Iron sectional boilers are a general use in small systems that range up to 2,000,000 btu/hour. The chief use of these boilers is to replace existing boilers, as they can be assembled in place and do not require a large building opening.

#### Good points:

Since these boilers are made of Cast Iron, they are not as subject to corrosion as a steel boiler.

Although sold with atmospheric burners, KJWW specifies only power burners unless for small residential uses.

#### Problems:

Small steaming cavity, therefore good for small closed loop systems only.

Dirty systems cause the boiler to surge.

Maximum pressure on steam is 15 psig.

### Fire Box type Boilers:

These boilers are a fire tube boiler and are development of the railroad locomotives. They are very common in schools and hospitals built in the 40's and 50's. Many of these boilers are set on high bases of steel or brick so that they could be coal fired.

#### Good Points:

Long life expectancy, as it is a steel boiler and can be welded and rewelded forever. Mud legs can be replaced for about \$15,000 on a 200 hp boiler.

Due to it's design, any height can be achieved under the boiler for firing various fuels such a coal, sawdust, oat hulls and etc. When using these fuels, specify large flues to prevent clogging. Maybe a soot blowing arrangement is in order.

With the extended base, it is easy to fire coal or sawdust while burning natural gas at the same time. They are used with stokers with a gas burner above the grate.

Has a large water volume and surface area therefore can be used in dirty systems or systems that have a high percentage of make-up water.

**Problems:**

The design of the "mud legs" create natural pockets for corrosion. Unless maintained exceptionally well, these legs will require replacing every 15 to 20 years.

Maximum pressure for these boilers is approximately 150 psig.

Maximum size is approximately 550 hp. This is due to the transporting problems on a truck.

Subject to thermal shock.

On an existing boiler, if it was designed for coal firing, then turbulators may improve the heat transfer which will improve the efficiency.

Since the bottom of the boiler is firebrick, this must be maintained in good repair. Special care is required to design this base correctly to prevent damage to the boiler room floor.

Typically these boilers are larger in size than the same capacity scotch-marine boiler.

**Scotch Marine Boilers:**

These boilers, as the name implies, were developed for marine service and then adapted to the building industry. They are fire-tube type boilers and the fuel is burned in the "Morrison" or furnace tube. Since this tube is completely surrounded with water, maximum heat transfer is achieved.



**Good Points:**

Very compact, as 750 hp boilers can be shipped by truck.

Maximum steam pressure is approx 250 psig.

Good efficiency. Standard is approx 83%.

Not subject to shock as much as other boilers.

Can be fired with gas or light oil. Have problems with heavy oils with some units. Kewanee claims to have a design that will burn coal???

The design is rugged, and many of the waste heat boilers used in incinerator plants are scotch marine type.

**Problems:**

Maximum steam pressure is 250 psig.

Maximum steam capacity is 750 BHP (25,000 #/Hr)

One piece construction, therefore difficult to get into and out of a boiler room. (Can be cut and rewelded, but is expensive.

Turndown on oil is not too great, but a minor problem.

**WATER TUBE BOILERS:**

These boilers are designed for high pressure systems. They are used in the generation of electrical power. They are built by using a minimum of 2 drums, the upper steam drum and the lower mud drum. Between these drums are connected the tubes that carry the water and steam.

**Good Points:**

Good for high pressures up to critical pressures.

Unlimited size.

Can be used to burn any fuel as each is more or less custom designed.

Small units, up to approx 250 BHP, can be packaged.

Can superheat steam.

**Problems:**

On large field erected units, the labor is expensive.

Small steaming surface, therefore not good to use for process steam.--unless

Water treatment is more critical with these boilers.

PROJECT STEAM SEMINAR	DATE 10-5-89	BY SCW	PROJECT NO. 30000
--------------------------	-----------------	-----------	----------------------

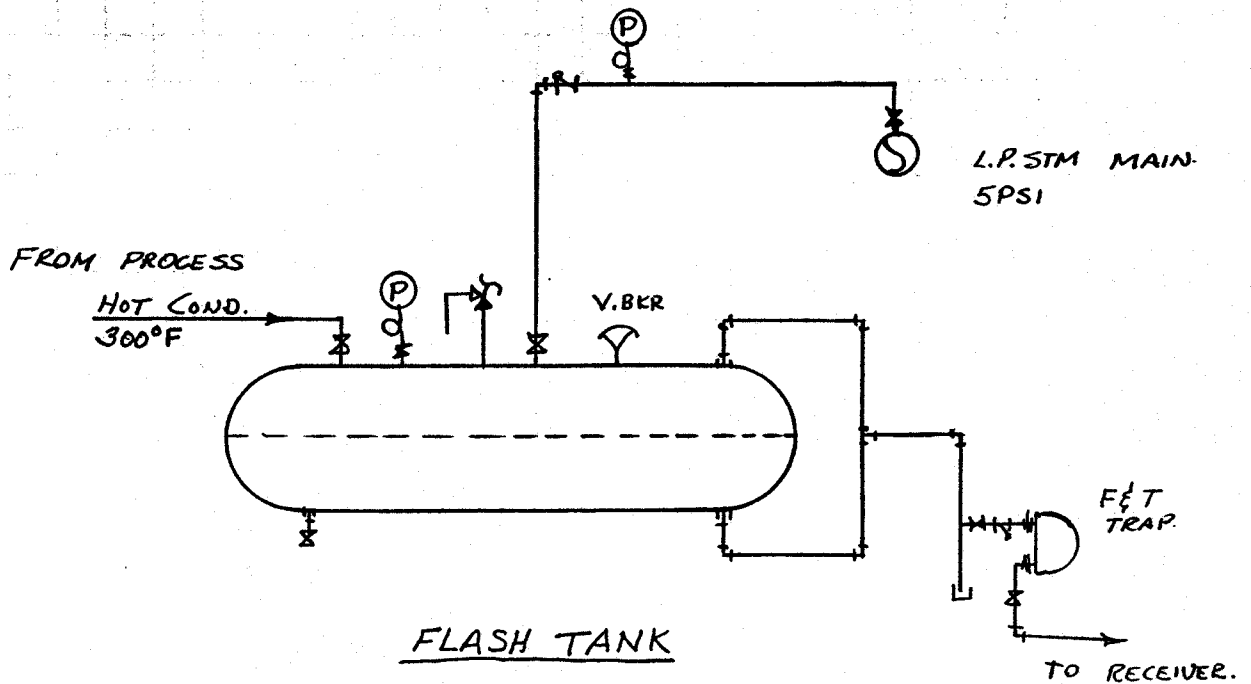

1. ENTERING COND. = 300°
2. LEAVING COND. = 227°
3. EACH # gives UP  $300 - 227 = 73°$   
= 73 BTU
4. For 1000 #/hr of 300° Condensate  
 $1000 \times 73 = 73,000$  BTU.
5.  $73,000 \text{ BTU} \div 960 \text{ BTU/\#} = 76 \text{ \#/hr of 5psi Steam generated.}$
6. SAVINGS:
  - a) loss of 76 # water/hr (9 gallons)
  - b) 73,000 BTU/hr for 8 hours = 5.84 Therms of heat (@ 60¢/therm = \$3.50)
  - c) less Chemical Treatment on Boiler.

**if the job  
involves liquid  
level control,  
liquid flow  
or air flow...**

**MCDONNELL  
can help!**

**MCDONNELL  
Flow Switches  
for Liquid  
and Air**

Make or break a circuit with "Flow" or "No Flow" in pipelines and ducts. Over two dozen standard models available to meet almost any job requirement. Below are a few of the many places they are being used as automatic controllers and safety devices:

- Air Conditioning Systems
- Water Supply Systems
- Pump Systems
- Water Cooled Equipment
- Sprinkler Systems
- Water Treatment Systems
- Liquid Transfer Systems
- Duct Heaters
- Exhaust Ventilating Systems
- Make-up Air Systems

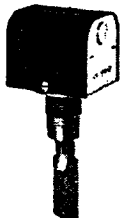

**No. FS4-3—**  
Compact, moderately priced, for water service principally. Wetted parts brass and monel.



**FS7 Series—**  
For heavier duty service, or process liquids. Standard, vapor-proof or explosion-proof models, with wetted parts either brass or stainless steel.

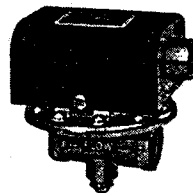

**No. FS1—**  
High sensitivity model. Combines response to low flow rates with large flow-through capacity.



**AF1 Series—**  
For use in air ducts. Responds only to velocity of air movement. Full line includes models for low, medium and higher velocity systems.

**MCDONNELL  
Pump Controllers  
and Low Water  
Cut-offs**

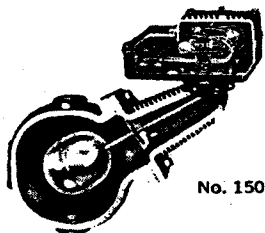

No. 150

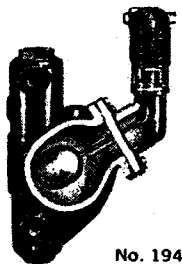

No. 194

These float-actuated switches control the boiler feed pump and provide low water cut-off and alarm. Available for pressures to 250 psi. Choice of mercury switch or magnetic repulsion switch action, round float bowl or integral water column. Used also as float operated switches for high or low level control on tanks and pressure vessels. (For make-up feeders for boiler feed pump systems, see Float-Operated Valves at right.)

**MCDONNELL  
Low Water  
Cut-offs**

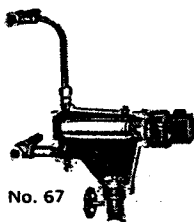

No. 67

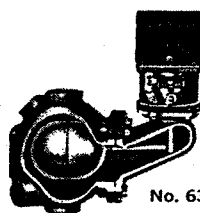

No. 63

These are float-operated controls designed to break the electrical circuit to the boiler firing device in the event of a low water condition. A full line of models is available, for both low pressure steam and hot water boilers.

**MCDONNELL  
Boiler Water  
Feeders and  
Feeder Cut-off  
Combinations**

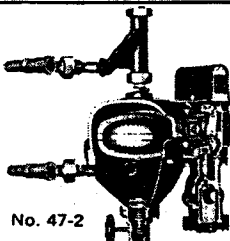

No. 47-2

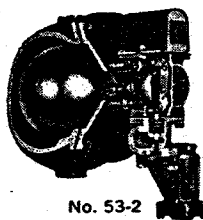

No. 53-2

These controls provide the dual protection of: 1, adding water (mechanically) to maintain a safe minimum water level; and 2, stopping the firing device (electrically) in case of emergency. A complete line is available for most steam and hot water boilers with operating pressures to 75 psi.

**MCDONNELL  
Float-operated  
Valves**

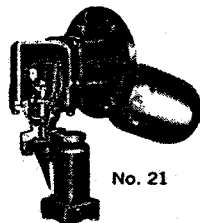

No. 21

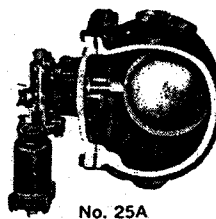

No. 25A

Incorporate heavy duty design for use on condensate receivers as well as other tanks and vessels. Several models are available, for either flange mounting or external hook-up. (Ideal for use as Make-up Water Feeders, in systems with Pump Controllers shown at left.)

**MCDONNELL  
Float-operated  
Switches**

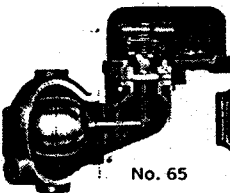

No. 65

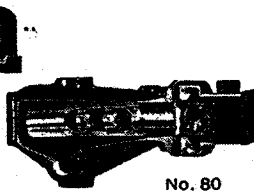

No. 80

Designed to make or break a circuit with rising or falling level in tanks or vessels. Explosion-proof 65 Series for use in Class 1, Groups C and D; Class 2, Groups E, F & G atmospheres. Vapor-proof 165 Series for use out-of-doors. No. 80 for use on oil storage tanks.

**MCDONNELL & MILLER**

3500 N. Spaulding Ave., Chicago, Ill. 60618  
Telephone: (312) 257-1600 Telex: 25-3376

**FLUID HANDLING DIVISION**  
INTERNATIONAL TELEPHONE



# UL/FM Systems

**Input Range 400mbh - 2499mbh**

The following systems which meet or exceed FM within this range are required.

**NOTE** Gas trains shown are for FM "Low Risk" below 50 boiler HP (2499 MBH). For FM "High Risk", use gas trains shown for 2500-5000 MBH input range.

System Designation	Combustion System Function
B	On-Off, Fixed Air and Fuel
H	On-Off or High-Low, Low Fire Start
E2	Modulating, Proven Low Fire Start

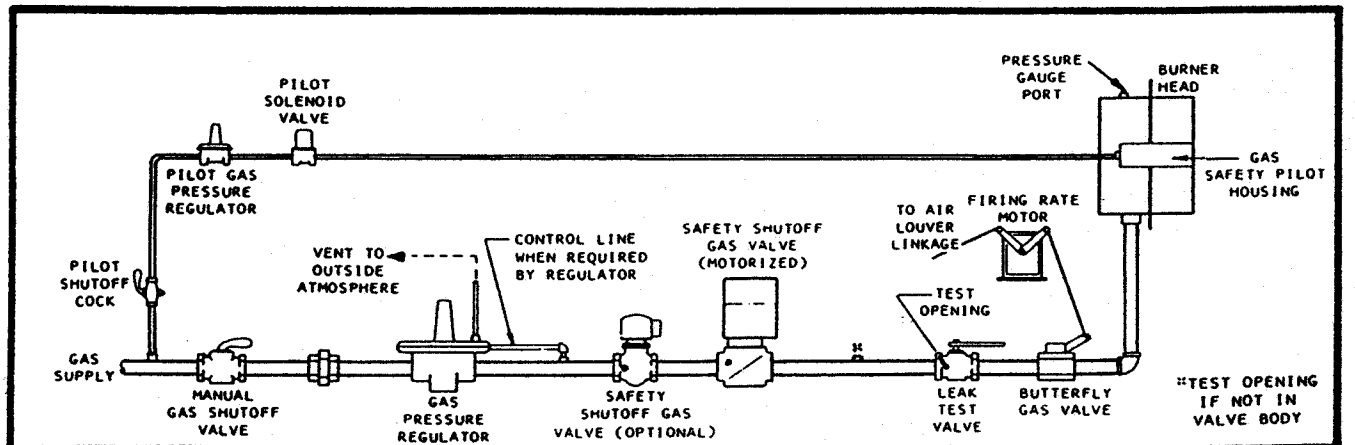
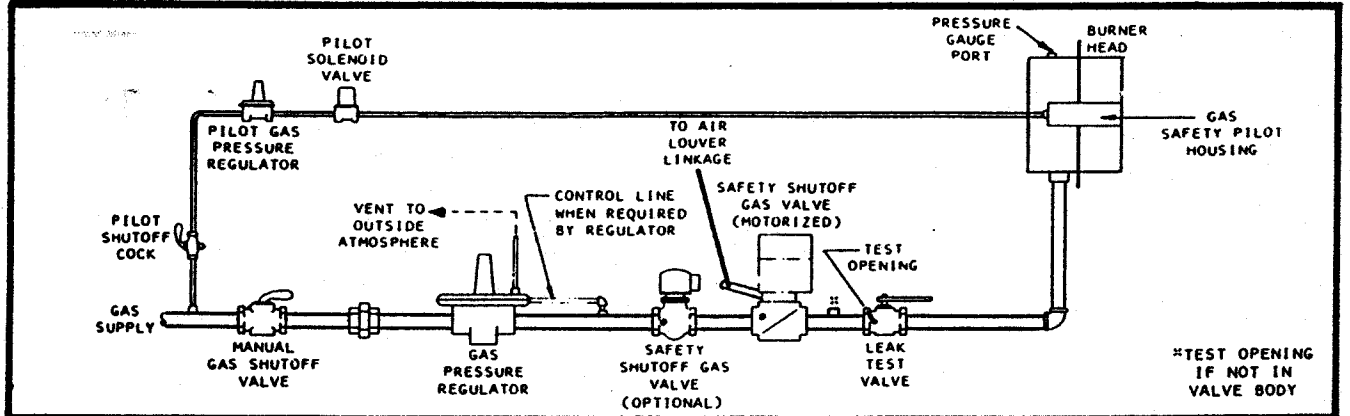
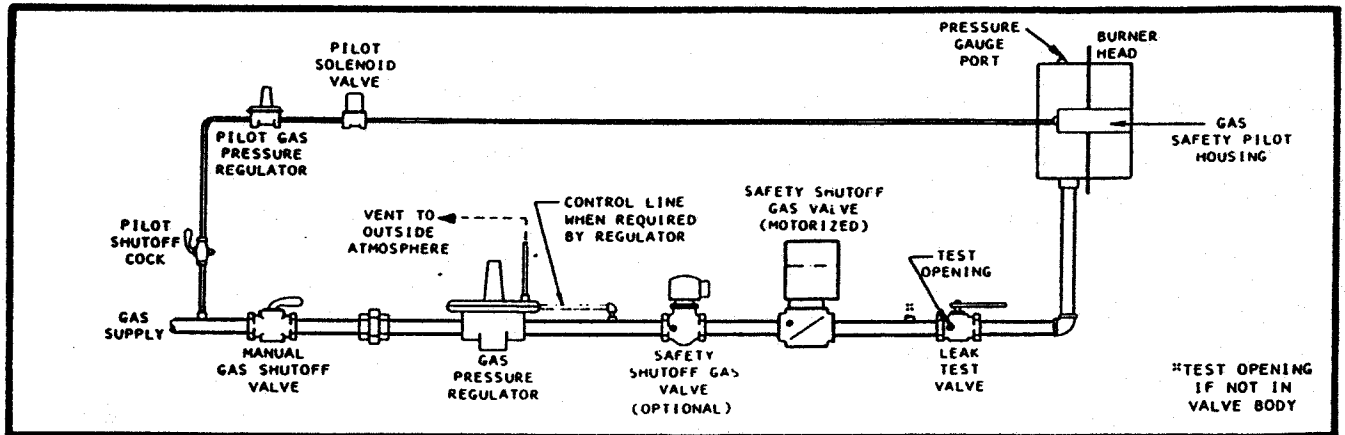

# UL/IRI Systems

**Input Range 400mbh - 2500mbh**

The following systems which meet or exceed IRI within this range are required.

System Designation	Combustion System Function
B	On-Off, Fixed Air and Fuel
H	On-Off or High-Low, Low Fire Start
E2	Modulating, Proven Low Fire Start

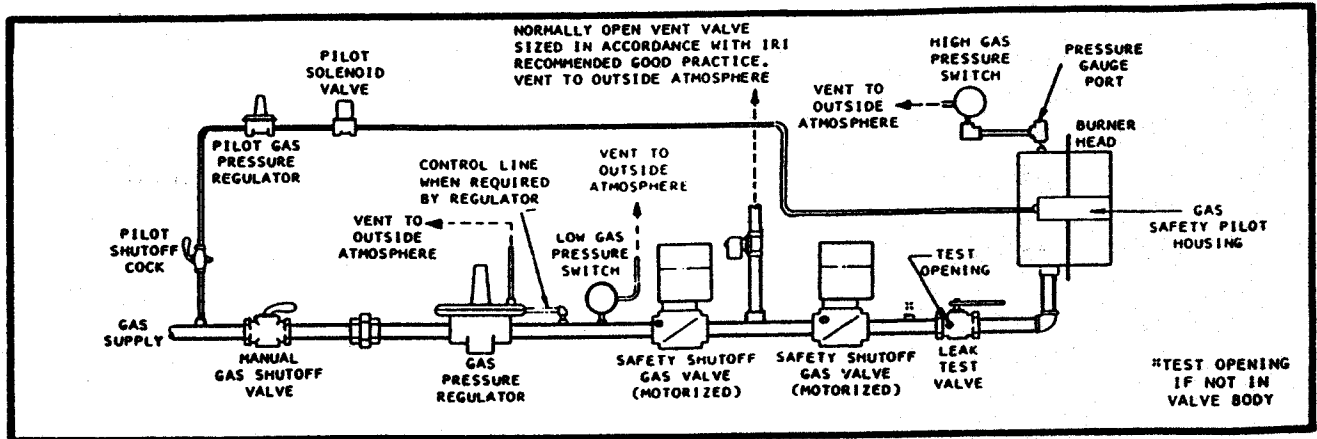

"B" Gas System Schematic (see Table VII, Catalog Sheet 6-15-1.1)

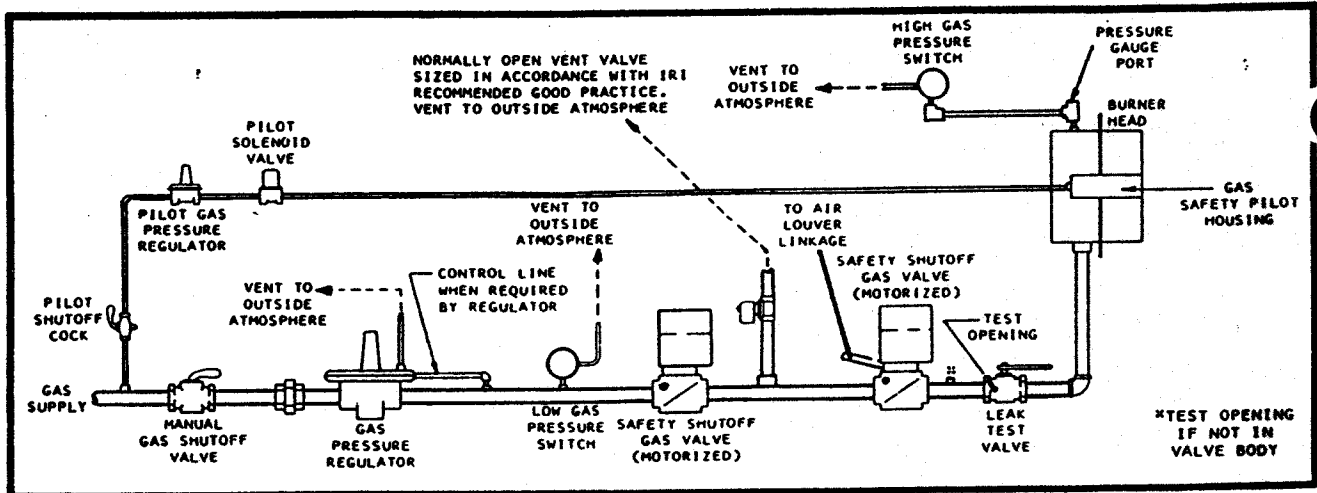

"H" Gas System Schematic (see Table VII, Catalog Sheet 6-15-1.1)

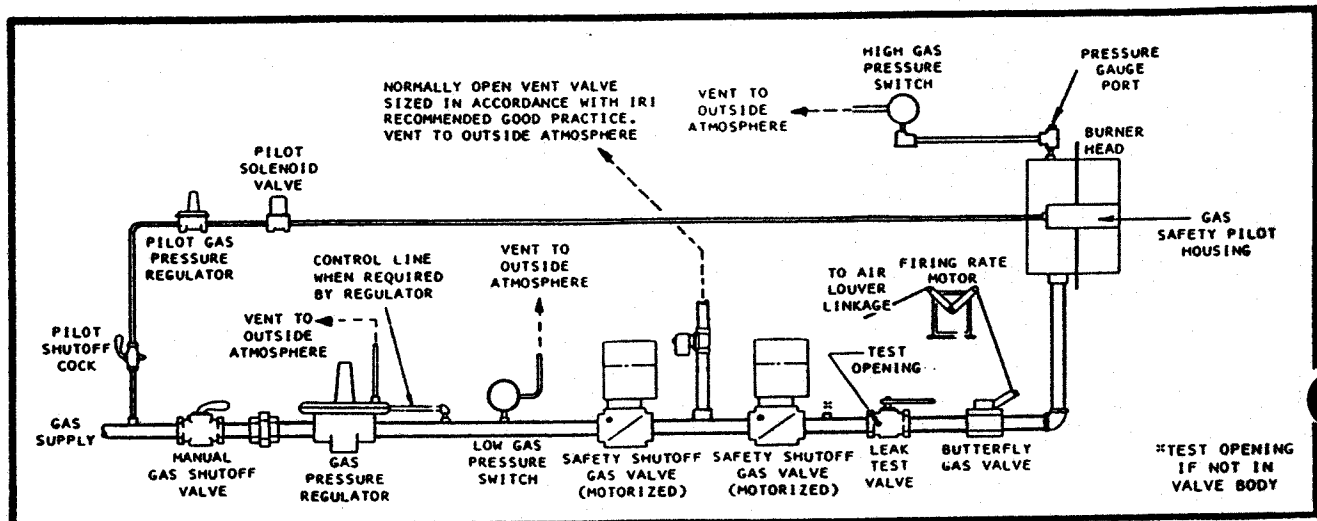

"E" Gas System Schematic (see Table VII, Catalog Sheet 6-15-1.1)

# UL/IRI Systems

**Input Range 250mbh - 5000mbh**

The following systems which meet or exceed IRI within this range are required.

<u>System Designation</u>	<u>Combustion System Function</u>
H	On-Off
E2	Modulating, Proven Low Fire Start

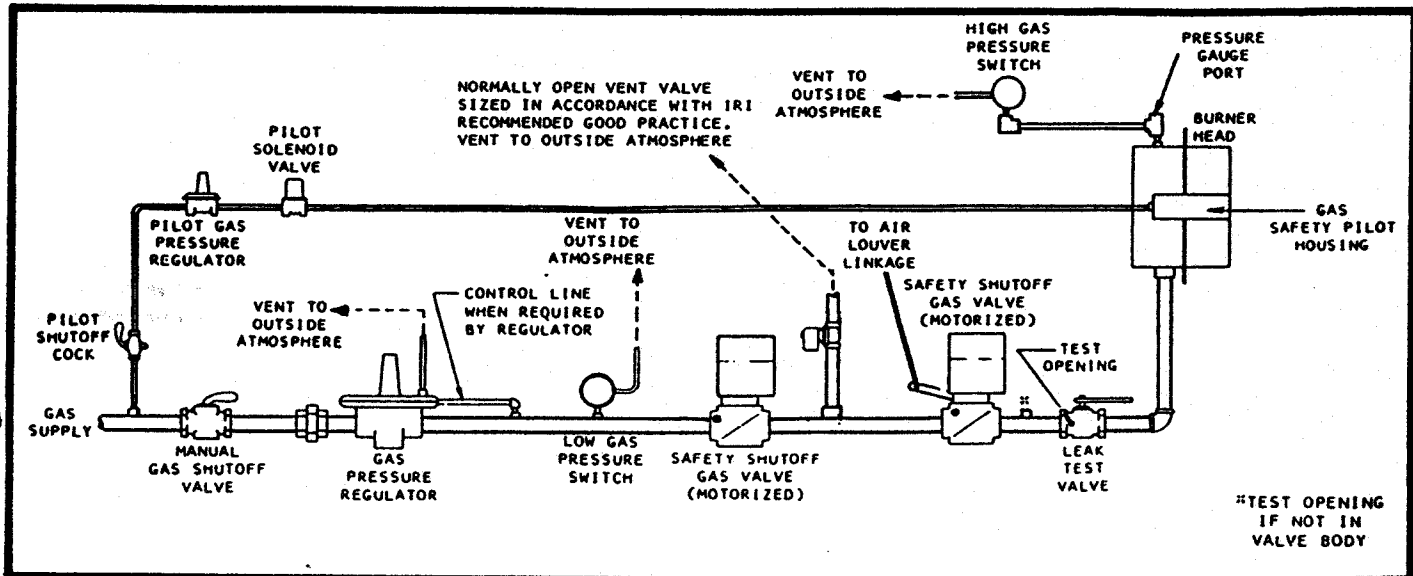

"H" Gas System Schematic (see Table VII, Catalog Sheet 6-15-1.1)

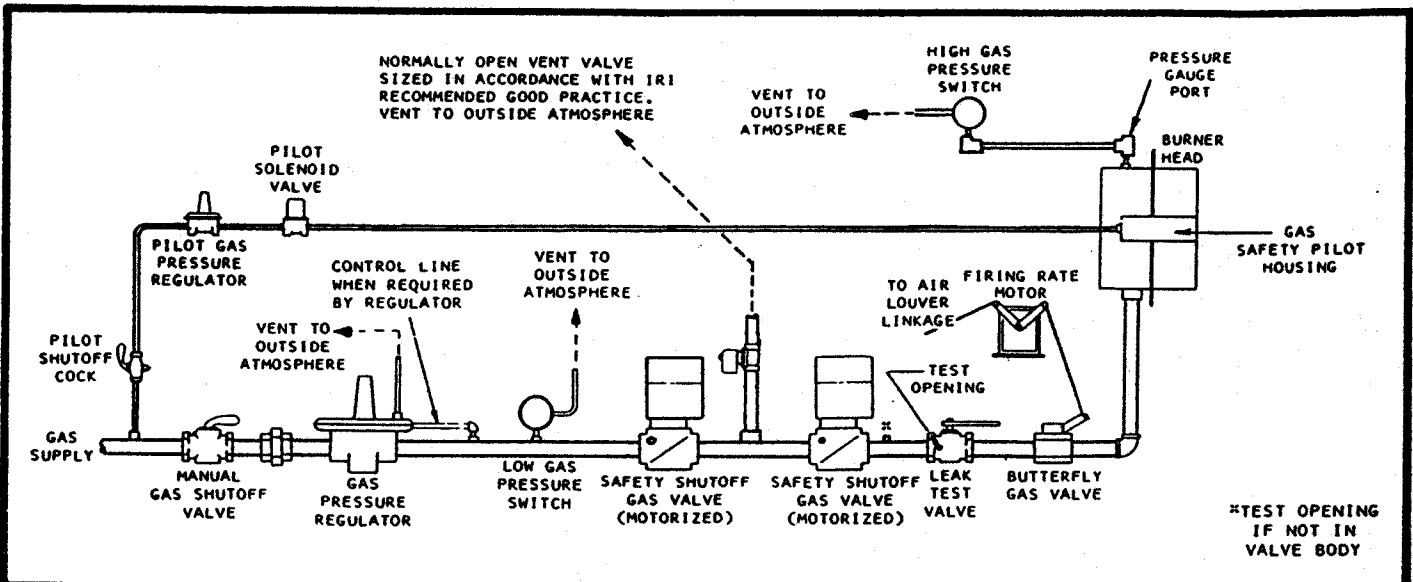

"E" Gas System Schematic (see Table VII, Catalog Sheet 6-15-1.1)

# UL/FM Systems

**Input Range 5001mbh - 12500mbh**

High-low or modulating "E" gas systems which meet or exceed FM within this range are required.

## System Designation

E2

## Combustion System Function

Modulating, Proven Low Fire Start

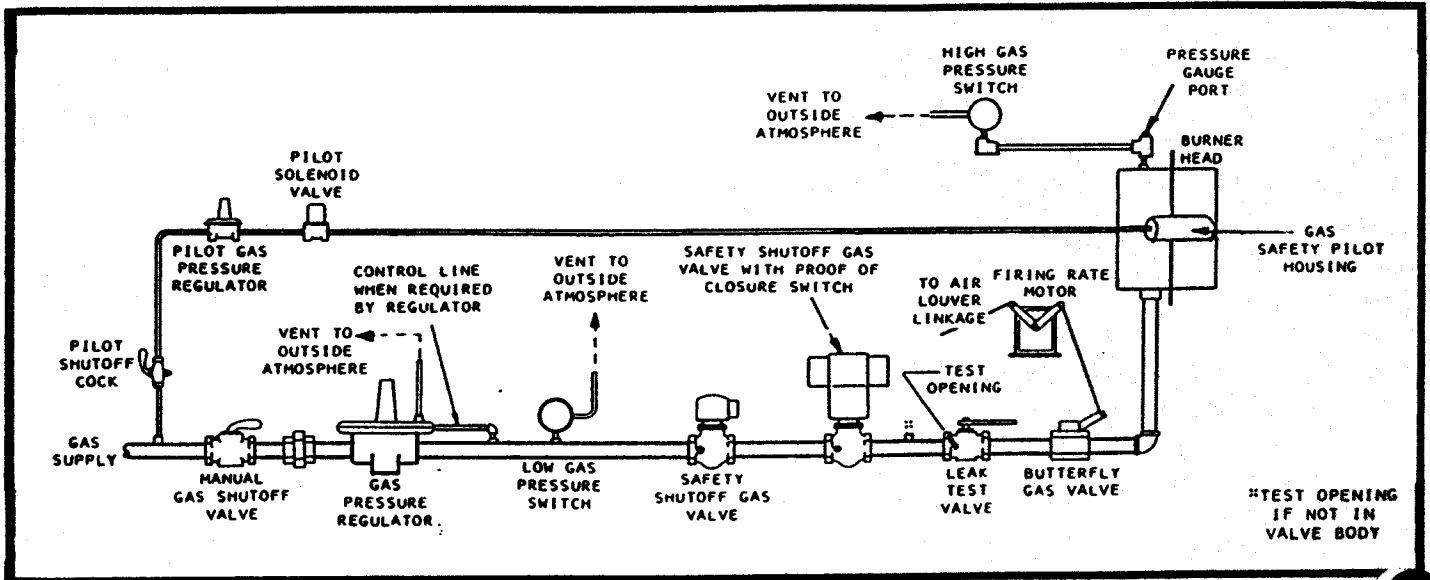

"E" Gas System Schematic (see Table V, Catalog Sheet 6-15-1.1)

# UL/IRI Systems

Modulating "E" gas systems which meet or exceed IRI within this range are required.

## System Designation

E2

## Combustion System Function

Modulating, Proven Low Fire Start

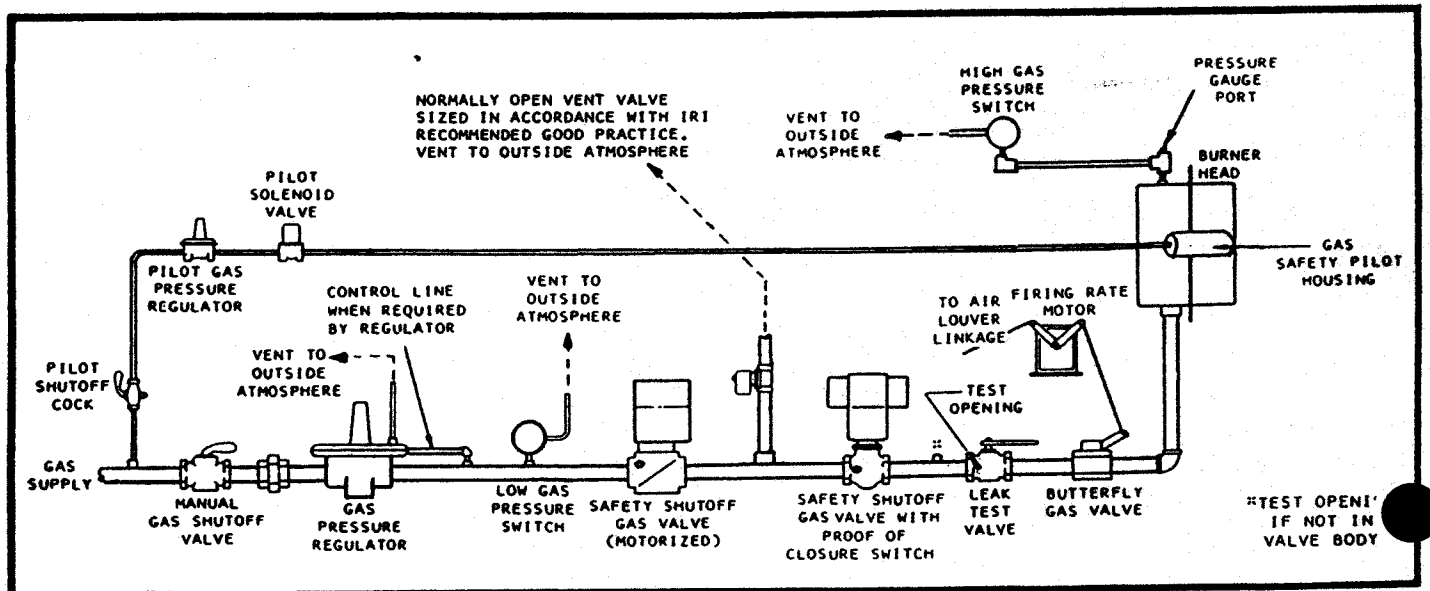

"E" Gas System Schematic (see Table VIII, Catalog Sheet 6-15-1.1)



# UL/FM Systems

## Input Range 1250lmbh and above

Modulating "E" gas systems which meet or exceed FM within this range are required.

### System Designation

E2

### Combustion System Function

Modulating, Proven Low Fire Start

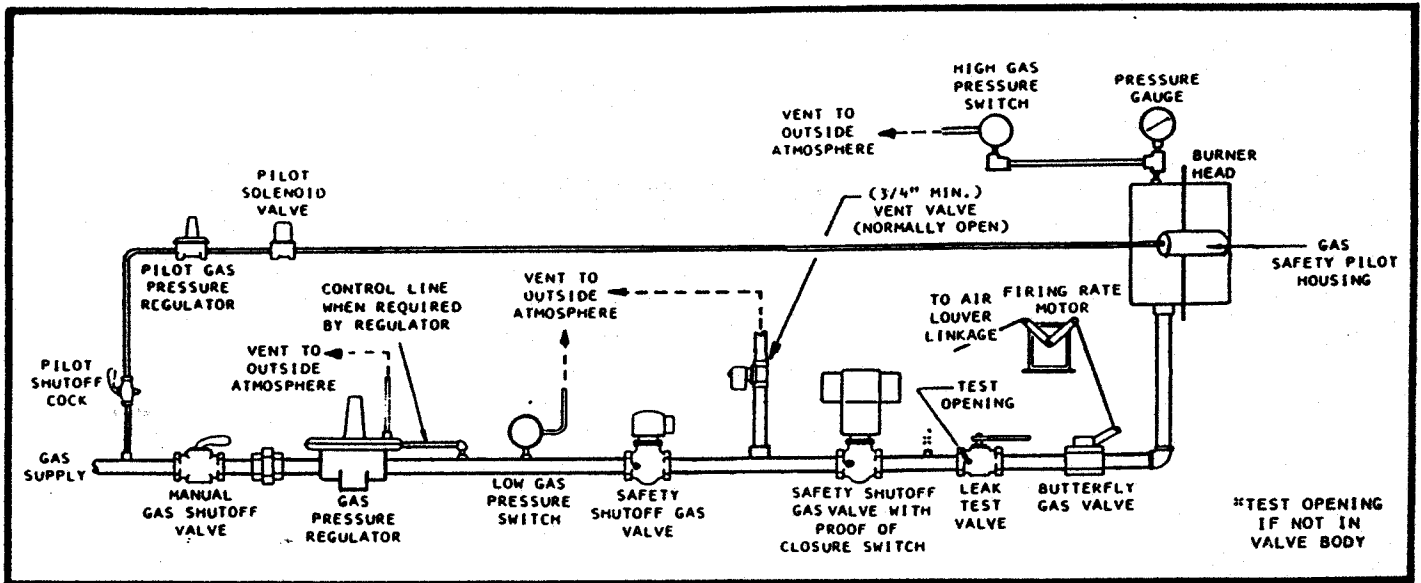

"E" Gas System Schematic (see Table VI, Catalog Sheet 6-15-1.1)

# UL/IRI Systems

Modulating "E" gas systems which meet or exceed IRI within this range are required.

### System Designation

E2

### Combustion System Function

Modulating, Proven Low Fire Start

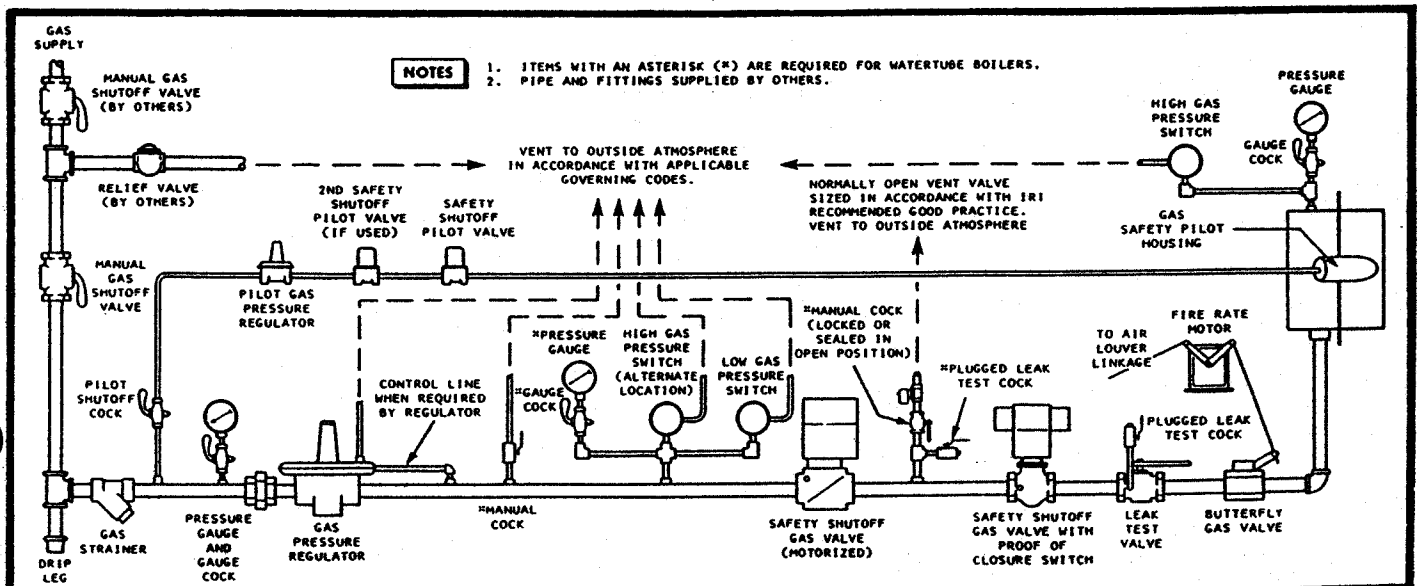

"E" Gas System Schematic (see Table VIII, Catalog Sheet 6-15-1.1)

# KUNKLE CAST IRON Accessories

## DRIP PAN ELBOWS

The illustration below shows Kunkle discharge elbow and drip pan unit attached to Figure 252 safety valve with female NPT outlet. For safety valves with flanged outlets—2" to 6"—use companion flange, short nipple and drip pan elbow, Figure 299, all same size as valve outlet.

8" Elbow has integral 125# ANSI Flange.

### RECOMMENDED INSTALLATION

**IMPORTANT**—Length of discharge piping must be kept to a minimum. For design considerations see articles, "Steam Flow Through Safety Valve Vent Pipes" by H. E. Brandmaier and M. E. Knebel (Dec. 1975) and "Analysis of Power Plant Safety and Relief Valve Vent Stacks" by G. S. Liao (Nov. 1974) available through ASME Publications.

**Type "A" installation**—for power boilers and unfired pressure vessel service.

**Type "B" installation**—for hot water boiler and generator service (160 PSIG/250° F. max.).

**Type "C" installation**—for low pressure steam boiler service (15 PSIG max.).

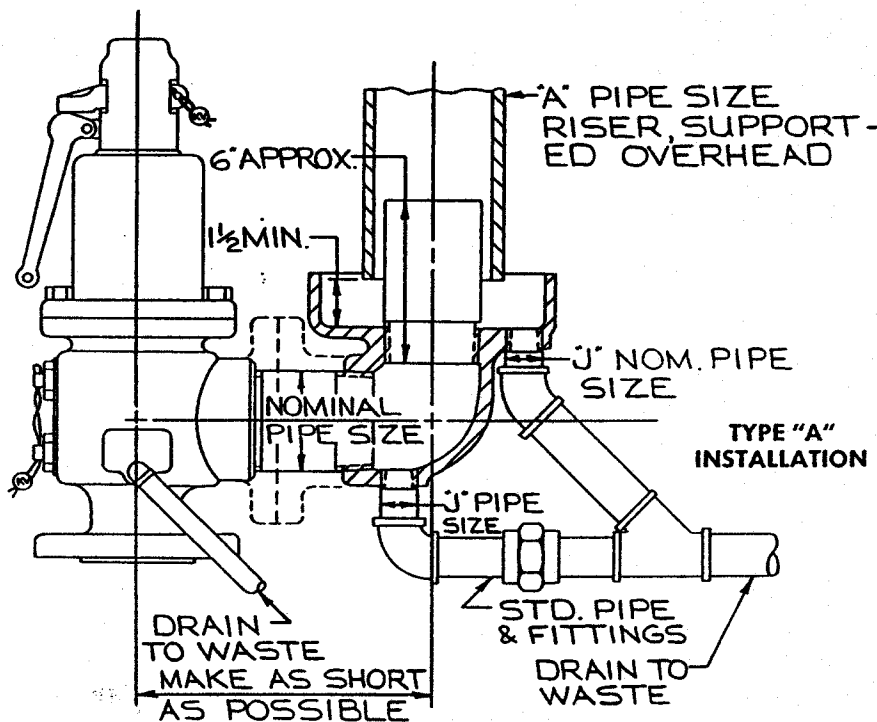

### DIMENSIONS

Size*	A	B	C	D	E	F	G	H	J	Wt. lbs.
2"	3	6 1/4	2 1/2	1 3/4	3 3/8	1 11/16	1 1/2	2 1/4	1/2	6
2 1/2"	3 1/2	7 3/8	2 3/4	2 3/8	4 3/8	1 13/16	1 5/8	2 11/16	3/4	10 1/2
3"	4	8	3 1/8	2 1/4	4 7/8	2 3/32	1 3/4	3 1/8	3/4	14
4"	6	9 3/8	3 3/4	2 1/2	5 3/4	2 3/8	1 3/4	3 3/4	3/4	26
6"	8	12 3/4	5 1/8	3 3/8	7 1/8	4 3/8	2 3/8	5 1/8	3/4	62
8"	10	16 1/2	6 3/8	3 3/4	9 1/8	5 3/8	7	10 3/4	1	102

\* Safety Valve Outlet and Fig. 299 Size.

# FIGURE 299

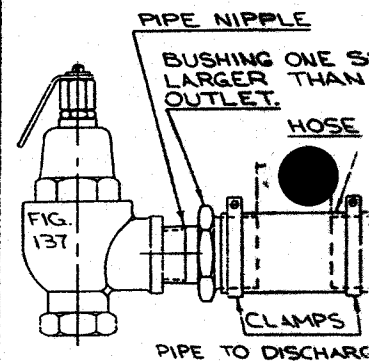
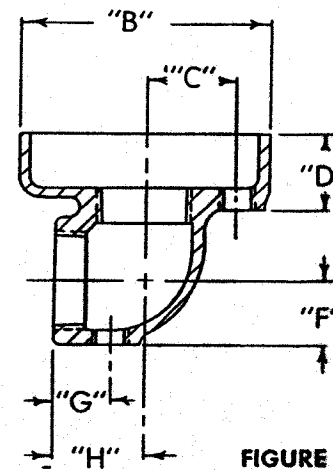

TYPE "B" INSTALLATION

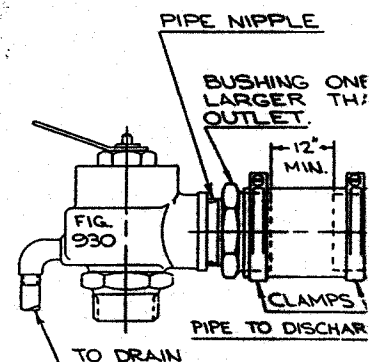

TYPE "C" INSTALLATION

**KUNKLE VALVE COMPANY, INC., FT. WAYNE, INDIANA**

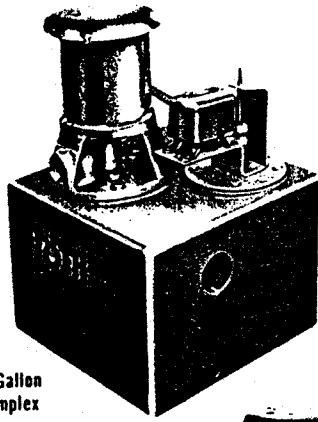

6 Gallon Simplex

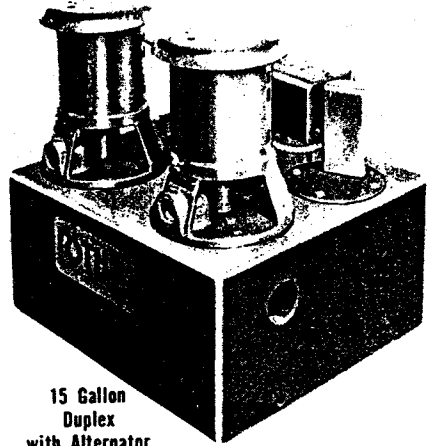

15 Gallon Duplex with Alternator

For peak storage, set float low.  
Will not vapor bind at 210°F.

For high temperature, set float high.  
Will not vapor bind at 212°F.

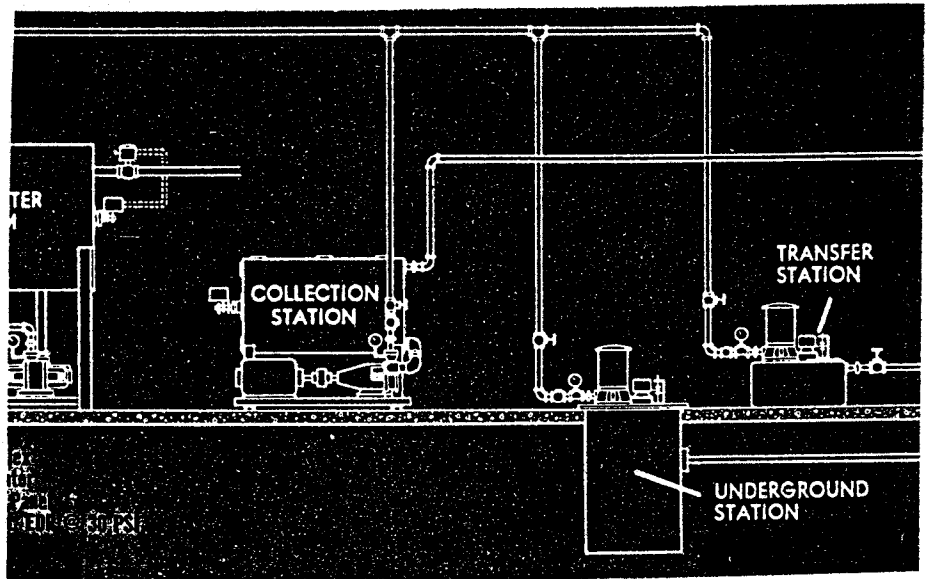
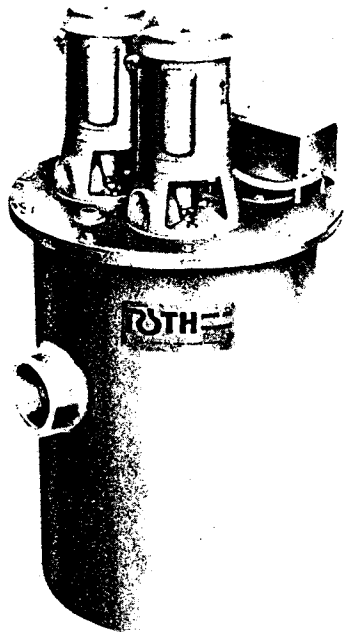
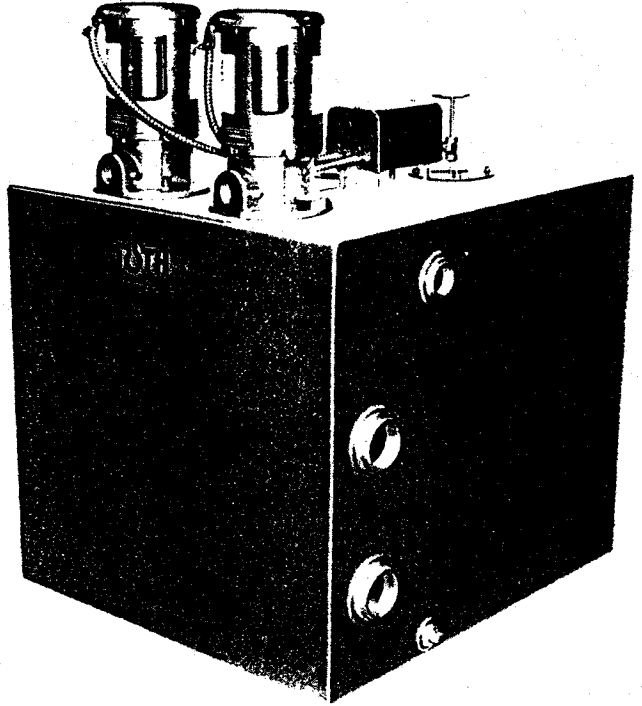

# Deaerator

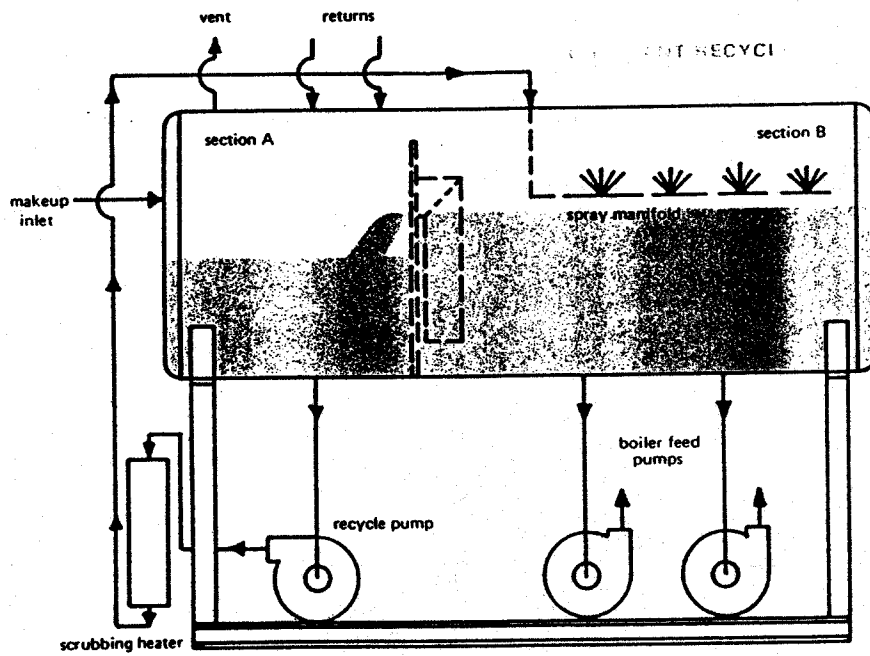
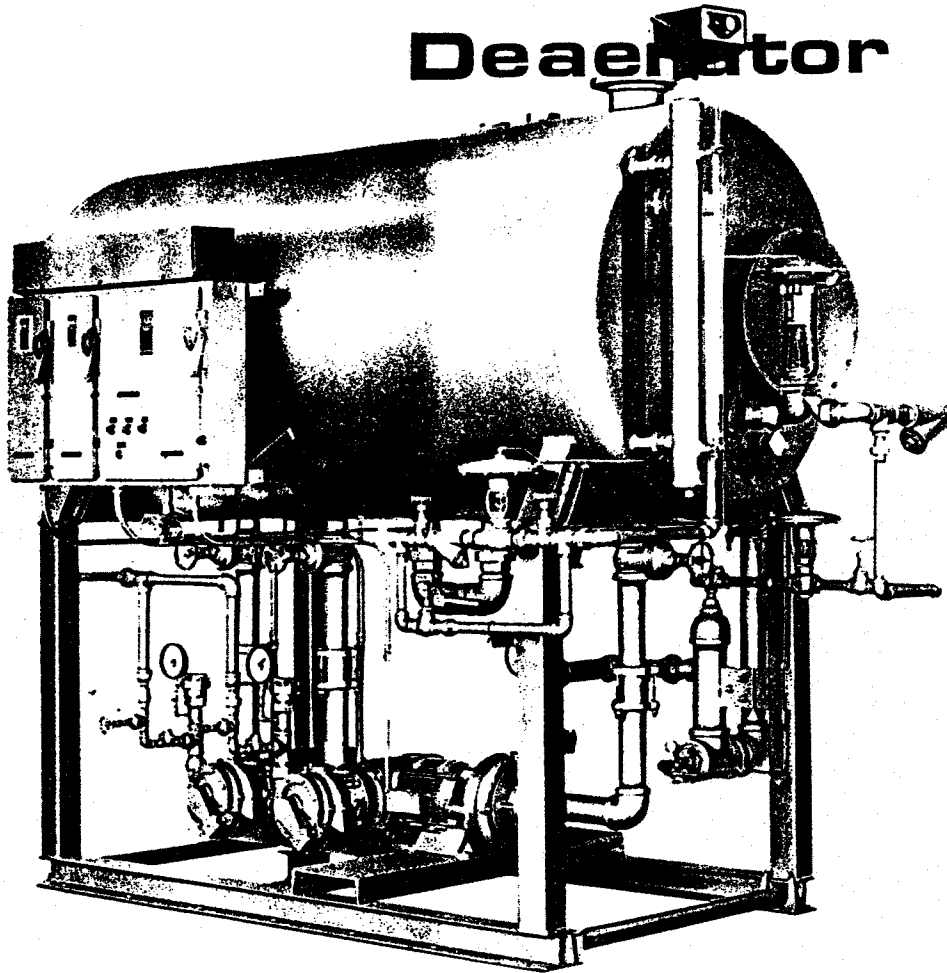

# ECONOMIZER

10 to 800 hp  
Firetube or Water Tube  
boilers



SAVES FUEL ... SAVES ENERGY ...

Engineered to efficiently recover invisible heat from boiler flue gases! Designed by the people who lead the way in Hot Water Heat Recovery

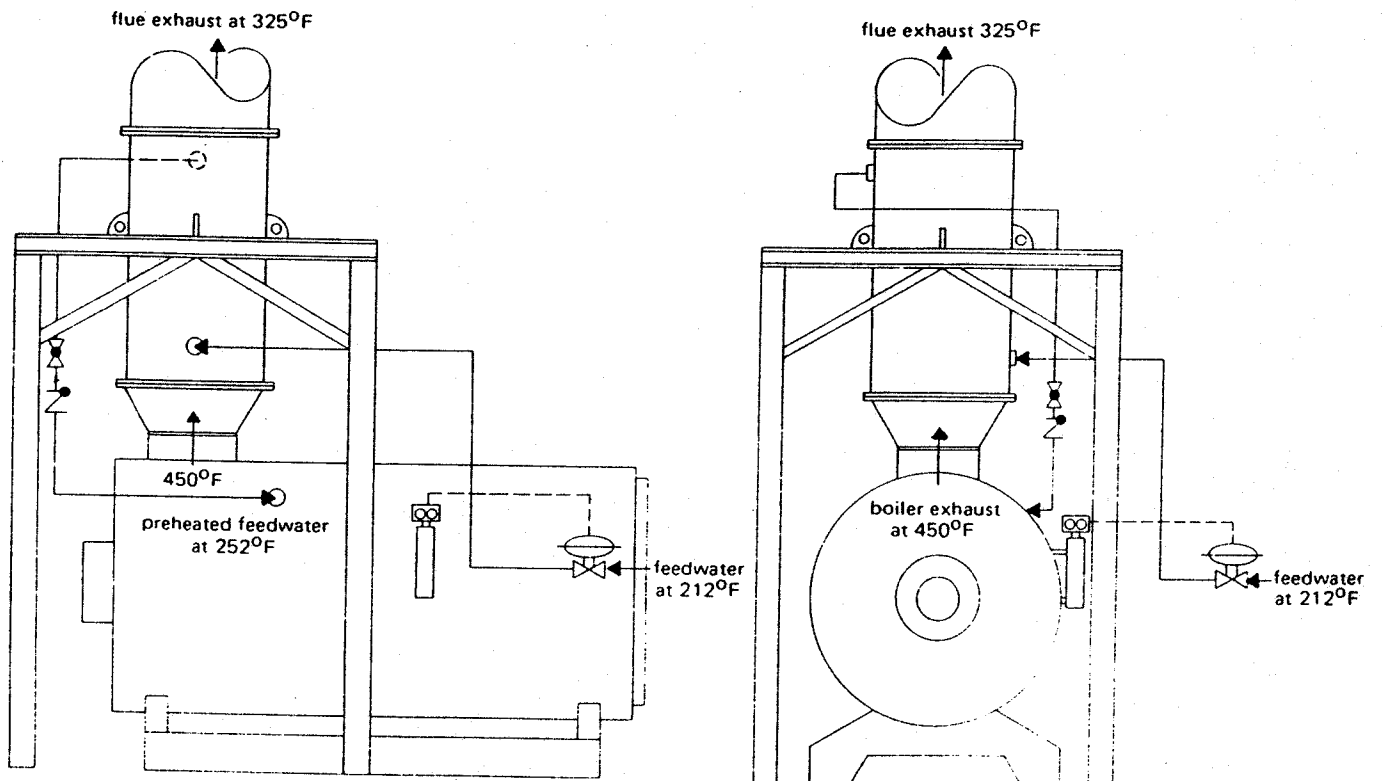

# STEAM TRAP SELECTION GUIDE

The chart below lists various steam trapping applications and enables the correct choice of trap to be made. The Fig. No. refers to the installation sketches given on pages 10 to 20.

A = First Choice

B = Alternate Choice

Application	Spirax Sarco FT Range (Float/Thermostatic)	Spirax Sarco FT/TV/SLR (Float/Thermostatic with Steam Lock Release)	Spirax Sarco FT/SLR (Float/Steam Lock Release)	Spirax Sarco TD Range (Thermodynamic)	Spirax Sarco BPT (Balanced Pressure Thermostatic)	Spirax Sarco SM (Bimetallic)	Spirax Sarco Thermoton (Liquid Expansion)	Spirax Sarco IB Range (Inverted Bucket)	Fig. Nos.
<b>CANTEEN EQUIPMENT</b>									
Boiling Pans — Fixed	A	B	B <sup>1</sup>	B <sup>1</sup>	B				17, 18
Boiling Pans — Tilting		A	B		B				19
Boiling Pans — Pedestal	B	B	B <sup>1</sup>		A <sup>2</sup>				
Steaming Ovens					A <sup>2</sup>				
Hot Plates	B	B	B <sup>1</sup>		A <sup>2</sup>				
<b>FUEL OIL HEATING</b>									
Bulk Oil Storage Tanks				A				B <sup>1</sup>	43, 44, 45
Line Heaters	A							B <sup>1</sup>	
Outflow Heaters	A							B <sup>1</sup>	46
Tracer Lines & Jacketed Pipes				B	A <sup>2</sup>	B	B		49, 50, 51
<b>HOSPITAL EQUIPMENT</b>									
Autoclaves and Sterilizers	B	B	B <sup>1</sup>		A			B	16
<b>INDUSTRIAL DRYERS</b>									
Drying Coils (continuous)	A				B	B		B	27
Drying Coils (grid)					B	A		B <sup>1</sup>	28
Drying Cylinders	B	A	B <sup>1</sup>					B <sup>1</sup>	30, 32
Multi Bank Pipe Dryers	A				B			B <sup>1</sup>	29
Multi Cylinder Sizing Machines	B	A	B <sup>1</sup>					B <sup>1</sup>	31
<b>LAUNDRY EQUIPMENT</b>									
Garment Presses	B			A				B	34
Ironers and Calenders	B	A	B <sup>1</sup>	B <sup>1</sup>	B			B <sup>1</sup>	33
Solvent Recovery Units	A			B				B	35
Tumbler Dryers	A	B	B <sup>1</sup>					B <sup>1</sup>	15
<b>PRESSES</b>									
Multi Platen Presses (parallel connections)	B			A				B	39, 40
Multi Platen Presses (series connections)				A <sup>1</sup>				B <sup>1</sup>	41
Tire Molds	B			A	B			B	42
<b>PROCESS EQUIPMENT</b>									
Boiling Pans — Fixed	A	B	B <sup>1</sup>	B <sup>1</sup>	B				17, 18
Boiling Pans — Tilting		A	B						19
Brewing Coppers	A	B	B <sup>1</sup>					B <sup>1</sup>	26
Digesters	A			B <sup>1</sup>				B <sup>1</sup>	22
Evaporators	A	B	B <sup>1</sup>					B <sup>1</sup>	25
Hot Tables				B	A				23
Retorts	A							B <sup>1</sup>	20, 21
Bulk Storage Tanks				A <sup>1</sup>				B <sup>1</sup>	43
Vulcanizers	B			A				B <sup>1</sup>	24
<b>SPACE HEATING EQUIPMENT</b>									
Shell & Tube Heat Exchangers	A	B	B <sup>1</sup>					B <sup>1</sup>	8
Heating Coils	A	B	B <sup>1</sup>					B <sup>1</sup>	13, 14, 15
Radiant Panels & Strips	A	B	B <sup>1</sup>	B <sup>1</sup>				B <sup>1</sup>	10
Radiators & Convection Cabinet Heaters	B				A	B			9
Overhead Pipe Coils	B				A			B <sup>1</sup>	11, 12
<b>STEAM MAINS</b>									
Horizontal Runs	B			A	B <sup>2</sup>			B	5
Separators	A			B	B <sup>2</sup>			B	4, 7
Terminal Ends	B			A <sup>1</sup>	B <sup>2</sup>			B <sup>1</sup>	6
Shut Down Drain (Frost Protection)					B <sup>2</sup>		A		
<b>TANKS AND VATS</b>									
Process Vats (Rising Discharge Pipe)	B			A	B			B	36
Process Vats (Discharge Pipe at Base)	A			B	B			B	37
Small Coil Heated Tanks (quick boiling)	A				B			B	
Small Coil Heated Tanks (slow boiling)							A		38

1. With air vent in parallel    2. At end of cooling leg Minimum length 3 ft (1m)    3. Use special tracing traps which offer fixed temperature discharge option.